



PIR & Light Sensor

Featuring LoRaWAN[®]

WS202

User Guide



Safety Precautions

Milesight will not shoulder responsibility for any losses or damages resulting from not following the instructions of this operating guide.

- ❖ The device must not be modified in any way.
- ❖ Do not expose the PIR lens to direct sunlight.
- ❖ Do not paint or clean the PIR lens, or it will affect the detection of the device.
- ❖ Do not place the device where the temperature is below/above the operating range.
- ❖ Do not place the device close to objects with naked flames, heat source (oven or sunlight), cold source, liquid and extreme temperature changes.
- ❖ The device is not intended to be used as a reference sensor, and Milesight will not take responsibility for any damages which may result from inaccurate readings.
- ❖ When installing the battery, please install it accurately, and do not install the reverse or wrong model.
- ❖ Remove the battery if the device will not be used for a long time. Otherwise, the battery will leak and damage the device.
- ❖ The device must never be subjected to shocks or impacts.

Declaration of Conformity

WS202 conforms with the essential requirements and other relevant provisions of the CE, FCC, and RoHS.

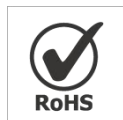

Copyright © 2011-2023 Milesight. All rights reserved.

All information in this guide is protected by copyright law. Whereby, no organization or individual shall copy or reproduce the whole or part of this user guide by any means without written authorization from Xiamen Milesight IoT Co., Ltd.

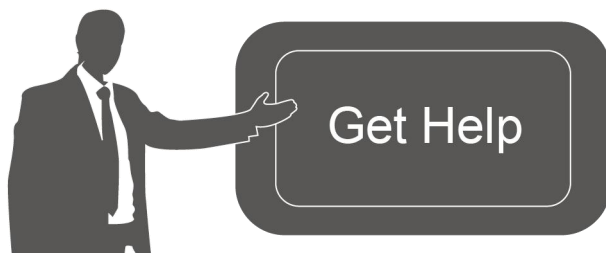

For assistance, please contact

Milesight technical support:

Email: iot.support@milesight.com

Support portal: support.mileisght-iot.com

Tel: 86-592-5085280

Fax: 86-592-5023065

Address: Building C09, Software Park III,
Xiamen 361024, China

Revision History

Date	Doc Version	Description
July 15, 2021	V 1.0	Initial version
Sept. 10, 2021	V 1.1	<ol style="list-style-type: none">1. Add Milesight D2D feature;2. Support light collection enabled/disabled;3. Delete low power alarm interval, device only uplinks once when battery level is lower than 10%.
Jan. 16, 2023	V 1.2	<ol style="list-style-type: none">1. Add Single-Channel mode;2. Add Milesight D2D LoRa Uplink feature.3. Add reboot downlink command.
May 15, 2023	V 1.3	Add blocking stickers

Contents

1. Product Introduction	5
1.1 Overview	5
1.2 Features	5
2. Hardware Introduction	5
2.1 Packing List	5
2.2 Hardware Overview	6
2.3 Dimensions (mm)	6
2.4 LED Patterns	7
3. Operation Guide	7
3.1 NFC Configuration	7
3.2 LoRaWAN Settings	8
3.3 General Settings	11
3.4 Threshold Settings	11
3.5 Milesight D2D Settings	12
3.6 Maintenance	12
3.6.1 Upgrade	12
3.6.2 Backup	13
3.6.3 Reset to Factory Default	14
4. Installation	14
5. Device Payload	15
5.1 Basic Information	16
5.2 Sensor Data	16
5.3 Downlink Commands	17

1. Product Introduction

1.1 Overview

WS202 is a PIR sensor based on passive infrared technology to detect a motion or occupancy. WS202 can detect whether there is a movement within the range of 6-8 m. Besides, WS202 equips with a light sensor which can link PIR detection results to trigger scenes. WS202 can be widely used in smart homes, smart offices, schools, warehouses, etc.

Sensor data are transmitted in real-time using the standard LoRaWAN® protocol. LoRaWAN® enables encrypted radio transmissions over long distances while consuming very little power. The user can get an alarm through Milesight IoT Cloud or through the user's own Application Server.

1.2 Features

- Built-in light sensor, combine PIR sensor to achieve triggers
- Up to 15 km communication range
- Easy configuration via NFC
- Standard LoRaWAN® support
- Compatible with Milesight IoT Cloud

2. Hardware Introduction

2.1 Packing List

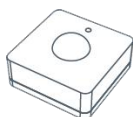

1 ×

WS202 Sensor



2 ×

Wall Mounting Kits



1 ×

3M Tape



3 ×

Blocking Stickers



1 ×

Quick Guide



If any of the above items is missing or damaged, please contact your sales representative.

2.2 Hardware Overview

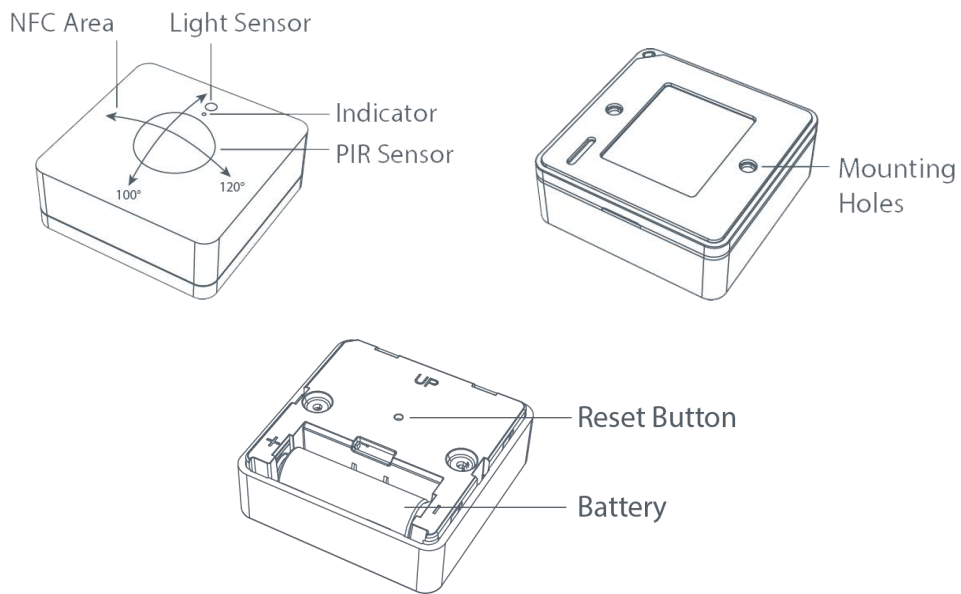

PIR Area

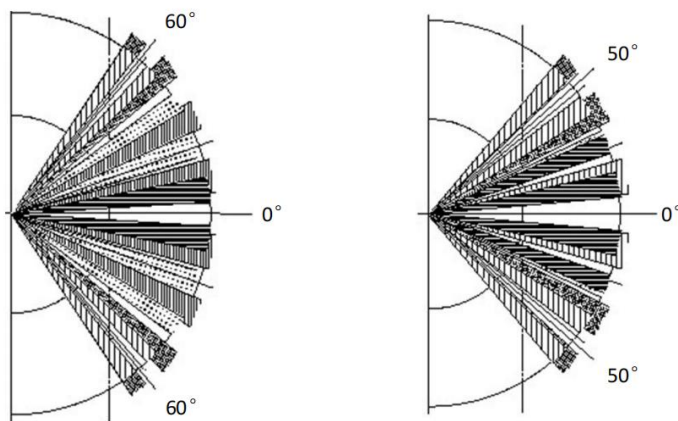

2.3 Dimensions (mm)

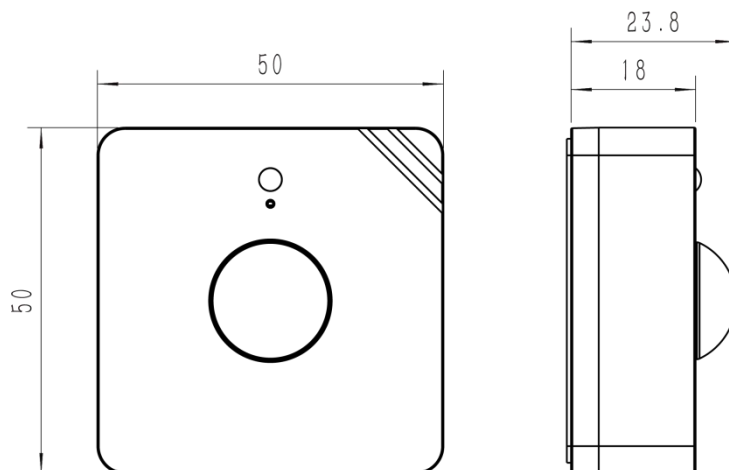

2.4 LED Patterns

Function	Action	LED Indicator
PIR Detection	PIR is triggered (network unregistered)	Red, blink once
	PIR is triggered (network registered)	Green, blink once
Network Status	Send join network requests	Red, blinks once
	Joined the network successfully	Green, blinks twice
Reboot	Press and hold the reset button for more than 3s	Slowly blinks
Reset to Factory Default	Press and hold the reset button for more than 10s	Quickly blinks

3. Operation Guide

3.1 NFC Configuration

WS202 can be configured via an NFC-enabled smartphone.

1. Pull out the battery insulating sheet to power on the device. The indicator will light up in green for 3 seconds when the device turns on.

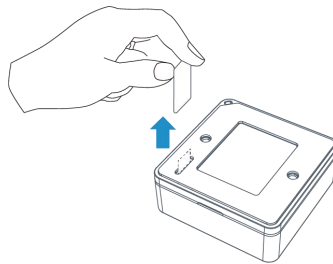

2. Download and install "Milesight ToolBox" App from Google Play or App Store.
3. Enable NFC on the smartphone and open Milesight ToolBox.
4. Attach the smartphone with NFC area to the device to read device information.



5. Basic information and settings of the device will be shown on ToolBox if it's recognized successfully. You can read and configure the device by tapping the Read/Write device on the App. In order to protect the security of the device, password validation is required when configuring via a new smartphone. The default password is **123456**.

Note:

- 1) Check the location of the smartphone NFC area and it's recommended to take off the phone case.
- 2) If the smartphone fails to read/write configurations via NFC, move the phone away and back to try again.
- 3) WS202 can also be configured by ToolBox software via a dedicated NFC reader provided by Milesight IoT, you can also configure it via TTL interface inside the device.

3.2 LoRaWAN Settings

Go to **Device > Setting > LoRaWAN Settings** of ToolBox App to configure join type, App EUI, App Key and other information. You can also keep all settings by default.

Device EUI

24E124538B223213

* APP EUI

24e124c0002a0001

* Application Port 85

Join Type

OTAA ▼

* Application Key

LoRaWAN Version

V1.0.3 ▼

Parameters	Description
Device EUI	Unique ID of the device which can also be found on the label.
App EUI	Default App EUI is 24E124C0002A0001.
Application Port	The port used for sending and receiving data. The default port is 85.
Join Type	OTAA and ABP modes are available.
LoRaWAN Version	V1.0.2, V1.0.3 are available.
Work Mode	It's fixed as Class A.
Application Key	Appkey for OTAA mode, default is 5572404C696E6B4C6F52613230313823.
Device Address	DevAddr for ABP mode, default is the 5 th to 12 th digits of SN.

Network Session Key	Nwkskey for ABP mode, default is 5572404C696E6B4C6F52613230313823.
Application Session Key	Appskey for ABP mode, default is 5572404C696E6B4C6F52613230313823.
RX2 Data Rate	RX2 data rate to receive downlinks or send D2D commands.
RX2 Frequency	RX2 frequency to receive downlinks or send D2D commands. Unit: Hz
Channel Mode	Select Standard-Channel mode or Single-Channel mode. When Single-Channel mode is enabled, only one channel can be selected to send uplinks. Please enable Single-Channel mode if you connect device to DS7610.
Channel	<p>Enable or disable the frequency to send uplinks.</p> <p>* Support Frequency</p> <p>EU868</p> <p><input checked="" type="checkbox"/> <input type="button" value="-"/> 868.1 <input type="button" value="+"/> <input type="button" value="v"/></p> <hr/> <p><input checked="" type="checkbox"/> <input type="button" value="-"/> 868.3 <input type="button" value="+"/> <input type="button" value="v"/></p> <hr/> <p><input checked="" type="checkbox"/> <input type="button" value="-"/> 868.5 <input type="button" value="+"/> <input type="button" value="v"/></p> <hr/> <p><input type="checkbox"/> <input type="button" value="-"/> 863 <input type="button" value="+"/> <input type="button" value="v"/></p> <p>If frequency is one of CN470/AU915/US915, enter the index of the channel that you want to enable and make them separated by commas.</p> <p>Examples: 1, 40: Enabling Channel 1 and Channel 40 1-40: Enabling Channel 1 to Channel 40 1-40, 60: Enabling Channel 1 to Channel 40 and Channel 60 All: Enabling all channels Null: Indicates that all channels are disabled</p>

	<p>* Support Frequency</p> <p>AU915</p> <p>Enable Channel Index ⓘ</p> <p>8-15</p> <table border="1"> <thead> <tr> <th>Index</th> <th>Frequency/MHz ⓘ</th> </tr> </thead> <tbody> <tr> <td>0 - 15</td> <td>915.2 - 918.2</td> </tr> <tr> <td>16 - 31</td> <td>918.4 - 921.4</td> </tr> <tr> <td>32 - 47</td> <td>921.6 - 924.6</td> </tr> <tr> <td>48 - 63</td> <td>924.8 - 927.8</td> </tr> <tr> <td>64 - 71</td> <td>915.9 - 927.1</td> </tr> </tbody> </table>	Index	Frequency/MHz ⓘ	0 - 15	915.2 - 918.2	16 - 31	918.4 - 921.4	32 - 47	921.6 - 924.6	48 - 63	924.8 - 927.8	64 - 71	915.9 - 927.1
Index	Frequency/MHz ⓘ												
0 - 15	915.2 - 918.2												
16 - 31	918.4 - 921.4												
32 - 47	921.6 - 924.6												
48 - 63	924.8 - 927.8												
64 - 71	915.9 - 927.1												
Spread Factor	If ADR is disabled, the device will send data via this spread factor.												
Confirmed Mode	If the device does not receive ACK packet from network server, it will resend data once.												
Rejoin Mode	<p>Reporting interval \leq 30 mins: the device will send a specific number of LinkCheckReq MAC packets to the network server with periodic or threshold uplinks everytime more than 25~35 mins passes to validate connectivity; If there is no response, the device will re-join the network.</p> <p>Reporting interval $>$ 30 mins: the device will send a specific number of LinkCheckReq MAC packets to the network server every reporting interval to validate connectivity; If there is no response, the device will re-join the network.</p>												
Set the number of packets sent	<p>When join mode is enabled, set the number of LinkCheckReq packets sent.</p> <p>Note: the actual sending number is Set the number of packet sent + 1.</p>												
ADR Mode	Allow network server to adjust data rate of the device. This only works with Standard Channel Mode.												
Tx Power	Transmit power of device.												

Note:

- 1) Please contact sales representative for device EUI list if there are many units.
- 2) Please contact sales representative if you need random App keys before purchase.

- 3) Select OTAA mode if you use Milesight IoT Cloud to manage devices.
- 4) Only OTAA mode supports rejoin mode.

3.3 General Settings

Go to **Device > Setting > General Settings** of ToolBox App to change the reporting interval, etc.

Reporting Interval 30 min

Idle Report Time/s ⓘ

LED Indicator ⓘ

Illuminance Collection ⓘ

Change Password

Parameters	Description
Reporting Interval	The interval of reporting PIR, light status and battery level to network server. Default: 30 mins, Range: 1 - 1080 mins Note: WS202 will also report "Occupied" status immediately when it detects motions.
Idle Time Reporting/s	When the PIR sensor does not detect motion for a period of Idle Time, device will report "Vacant" status. Default: 120 s
LED Indicator	Enable or disable the light indicating in chapter 2.4 . Note: The indicator of reset button is not allowed to disable.
Illuminance Collection	Enable or disable illuminance collection. When this is disabled, reporting interval will be changed to 1080 mins automatically.
Change Password	Change the password for ToolBox App to write this device.

3.4 Threshold Settings

When illuminance collection is enabled, users can define the Bright or Dark state via detection data of light sensor in threshold settings. Besides, when the PIR sensor is triggered and light status meets the threshold, WS202 will send alarms immediately. Otherwise, it will not send data right away.

Light State, Over/lux

100

Dark State, Below/lux

10

3.5 Milesight D2D Settings

Milesight D2D protocol is developed by Milesight and used for setting up transmission among Milesight devices without gateway. When the Milesight D2D setting is enabled, WS202 can work as a Milesight D2D controller to send control commands to trigger Milesight D2D agent devices.

1. Configure RX2 datarate and RX2 frequency in LoRaWAN® settings, it is suggested to change the default value if there are many LoRaWAN® devices around.

2. Go to **Device > Settings > D2D Settings** to enable D2D function, and define an unique Milesight D2D key which is the same as Milesight D2D agent devices, then select the frequency and spreading factor. (Default Milesight D2D Key: 5572404C696E6B4C6F52613230313823)

Enable



D2D Key

3. Enable one of WS202 status and configure a 2-byte hexadecimal command (This command is pre-defined in Milesight D2D agent device). When WS202 detects this status, it will send the control command to corresponding Milesight D2D agent devices.

Occupied/Bright



Control command

1

LoRa Uplink ⓘ



Occupied/Dark



Vacant



Note: If you enabled **LoRa Uplink** feature, LoRaWAN® uplink that contains the PIR status and light status will be sent to gateway after Milesight D2D control command is sent.

3.6 Maintenance

3.6.1 Upgrade

1. Download firmware from Milesight website to your smartphone.
2. Open ToolBox App and click "Browse" to import firmware and upgrade the device.

Note:

- 1) Operation on ToolBox is not supported during upgrade.
- 2) Only Android version ToolBox supports the upgrade feature.

Status	Setting	Maintenance
SN		6538B2232131
Model		WS202-470M
Firmware Version		V1.1-a0
Hardware Version		V1.0
Manual Upgrade		
<input type="button" value="Browse"/>		

3.6.2 Backup

WS202 supports configuration backup for easy and quick device configuration in bulk. Backup is allowed only for devices with the same model and LoRaWAN® frequency band.

1. Go to **Template** page on the App and save current settings as a template. You can also edit the template file.
2. Select one template file that saved in the smartphone and click **Write**, then attach it to another device to write configuration.

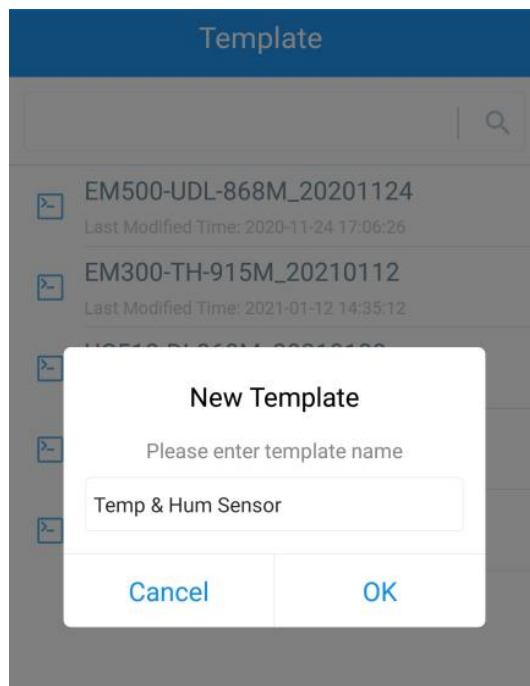

Note: Slide the template item to the left to edit or delete the template. Click the template to edit the configurations.

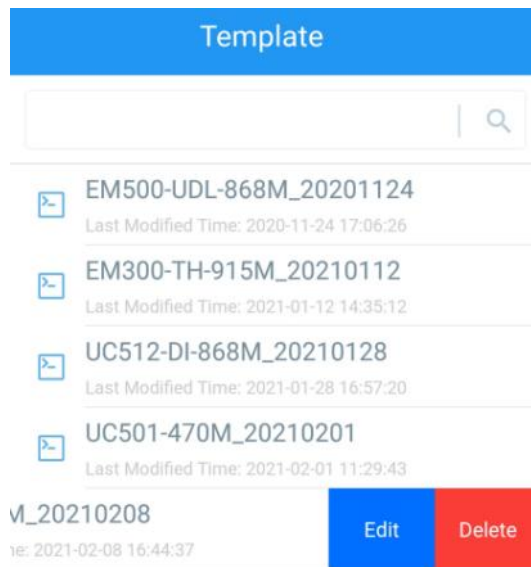

3.6.3 Reset to Factory Default

Please select one of the following methods to reset device:

Via Hardware: Hold on the reset button for more than 10s. After reset complete, the indicator will blink in green twice, then device will reboot.

Via ToolBox App: Go to **Device > Maintenance** to tap **Reset**, then attach smartphone with NFC area to device to complete reset.

4. Installation

Blocking Sticker Paste:

For applications requiring detection angle control, such as work station, in order to prevent accidental detection of people around the station, please paste the blocking stickers on the sensor along the bottom of the PIR lens for range shielding. Each sticker can cover about a 180° range. After paste the stickers along the bottom of the lens and wrapping the sensor 360°, the detection area has changed to 70° Horizontal, 60° Vertical.

Note: The detection area may be affected by manual pasting, potentially introducing errors.

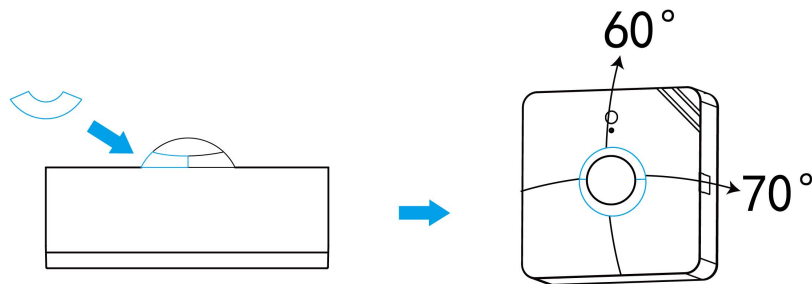

3M Tapes Fix:

Paste 3M tape to the back of the device, then tear the other side and place it on a flat surface.

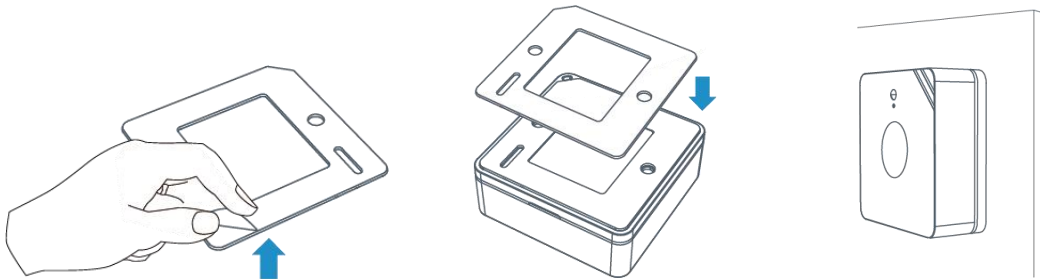

Screw Fix:

Remove the back cover of the device, screw the wall plugs into the wall and fix the cover with screws on it, then install back the device.

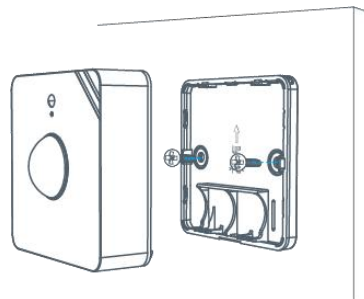

Note:

1. Adjust the installation direction according to detection area requirement.
2. WS202 can be mounted on a wall or ceiling. It's recommended to install at 1.5~2.5m from the floor.
3. Ensure the detection area does not have moving objects like waving trees and fans.
4. Ensure the detection area is not blocked by curtains or barriers.

5. Device Payload

All data are based on the following format (HEX), the Data field should follow little-endian:

Channel1	Type1	Data1	Channel2	Type2	Data2	Channel 3	...
1 Byte	1 Byte	N Bytes	1 Byte	1 Byte	M Bytes	1 Byte	...

For decoder examples, you can find them at <https://github.com/Milesight-IoT/SensorDecoders>.

5.1 Basic Information

WS202 reports basic information of the device whenever it joins the network.

Channel	Type	Description
ff	01(Protocol Version)	01=> V1
	08 (Device SN)	12 digits
	09 (Hardware Version)	01 40 => V1.4
	0a (Software Version)	01 14 => V1.14
	0b (Power On)	Device is on
	0f (Device Type)	00: Class A, 01: Class B, 02: Class C

Example:

ff0bff ff0101 ff086538b2232131 ff090100 ff0a0101 ff0f00					
Channel	Type	Value	Channel	Type	Value
ff	0b (Power On)	ff (Reserved)	ff	01 (Protocol Version)	01 (V1)
Channel	Type	Value	Channel	Type	Value
ff	08(Device SN)	6538b22321 31	ff	09 (Hardware version)	0100 (V1.0)
Channel	Type	Value	Channel	Type	Value
ff	0a (Software version)	0101 (V1.1)	ff	0f (Device Type)	00 (Class A)

5.2 Sensor Data

WS202 reports sensor data and battery level according to reporting interval (30 mins by default) or when PIR/light status changes. Besides, when battery level is lower than 10%, it will upload battery packet once.

Channel	Type	Description
01	75 (Battery Level)	UINT8, Unit: %
03	00 (PIR Status)	01: Occupied 00: Vacant
04	00 (Light Status)	01: Bright 00: Dark

Example:

01 75 64 03 00 01 04 00 01

Channel	Type	Value	Channel	Type	Value
01	75 (Battery)	64 => 100%	03	00 (PIR Status)	01=> Occupied
Channel	Type	Value			
04	00 (Light Status)	01=> Bright			

5.3 Downlink Commands

WS202 supports downlink commands to configure the device. The application port is 85 by default.

Channel	Type	Description
ff	03 (Set Reporting Interval)	2 Bytes, unit: s
	10 (Reboot)	ff (Reserved)

Example:

1. Set reporting interval as 20 minutes.

ff03b004		
Channel	Type	Value
ff	03 (Set Reporting Interval)	b0 04 => 04 b0 = 1200s = 20 minutes

2. Reboot the device.

ff10ff		
Channel	Type	Value
ff	10 (Reboot)	ff (Reserved)

-END-